

Drop wires

We can recommend the correct weight if you tell us the speed of the loom and count of the warp. We can offer up to 16g drop wires. Email us at info@transally.com.cn with your required specification or ask us for a product questionnaire. [Stainless steel and Nickel plated](#) are all available upon request.

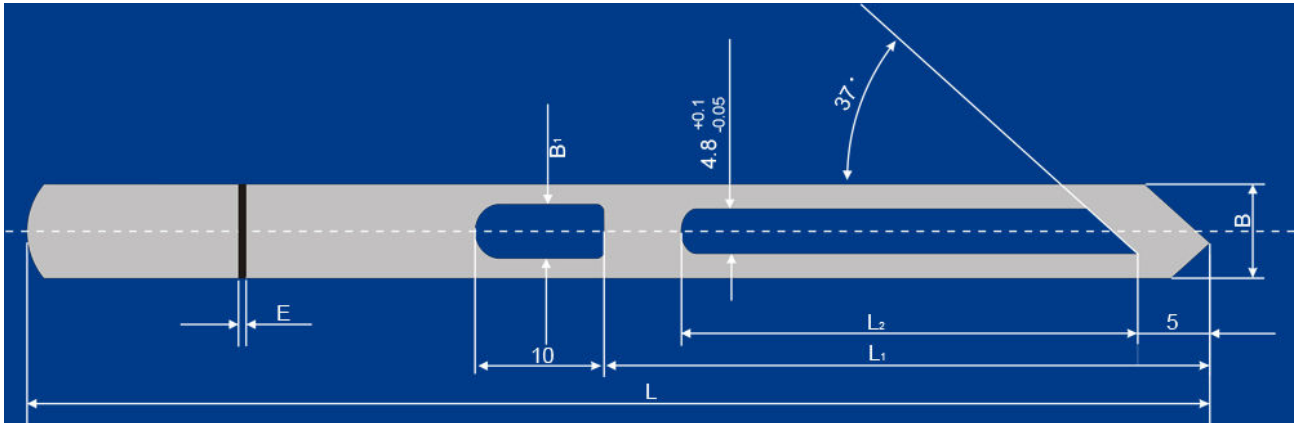

Closed, U type thread eye

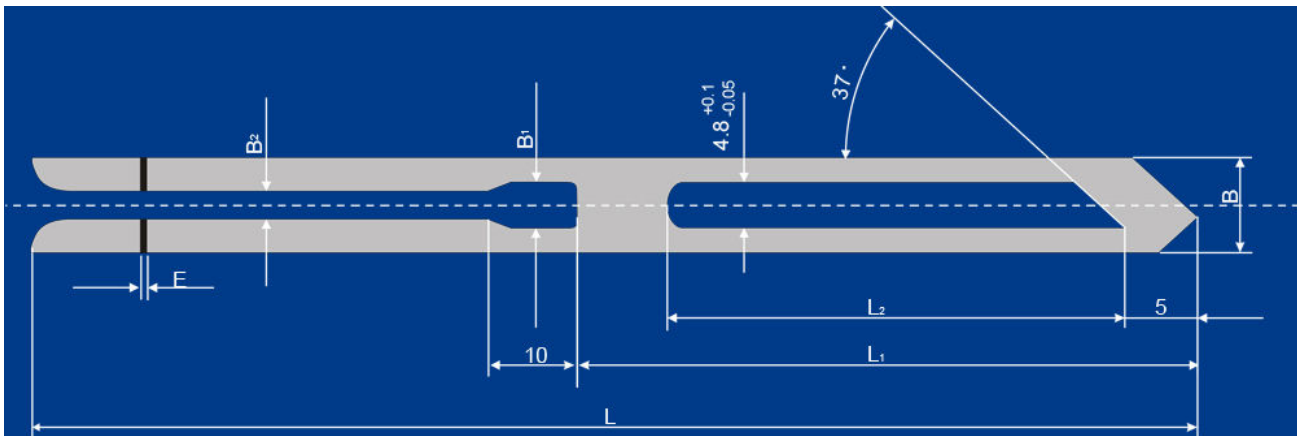

Open, U type thread eye

- L = Length of drop wire
- L1 = upper trough length
- L2 = upper length
- B = Width of drop wire
- B1 = Width of thread eye
- B2 = Width of lower trough
- E = Thickness of drop wire
- Measurement = Millimeter (mm)

TRANSALLY Weaving Machine Accessories Co., Ltd.

Add: D1-701 Fuyuan Business Building, Futian Free Trade Zone, Shenzhen, P.R. China

Tel: +86 755 83567270, 83592700, 21105700, 21107600 Fax: +86 755 83567370

Web: www.transally.com.cn Email: info@transally.com.cn, transally@vip.163.com

Outer Top Shape

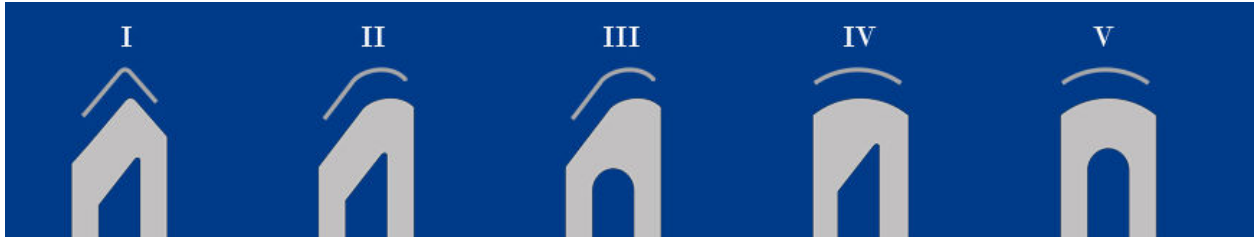

Drop Wire Eyelet

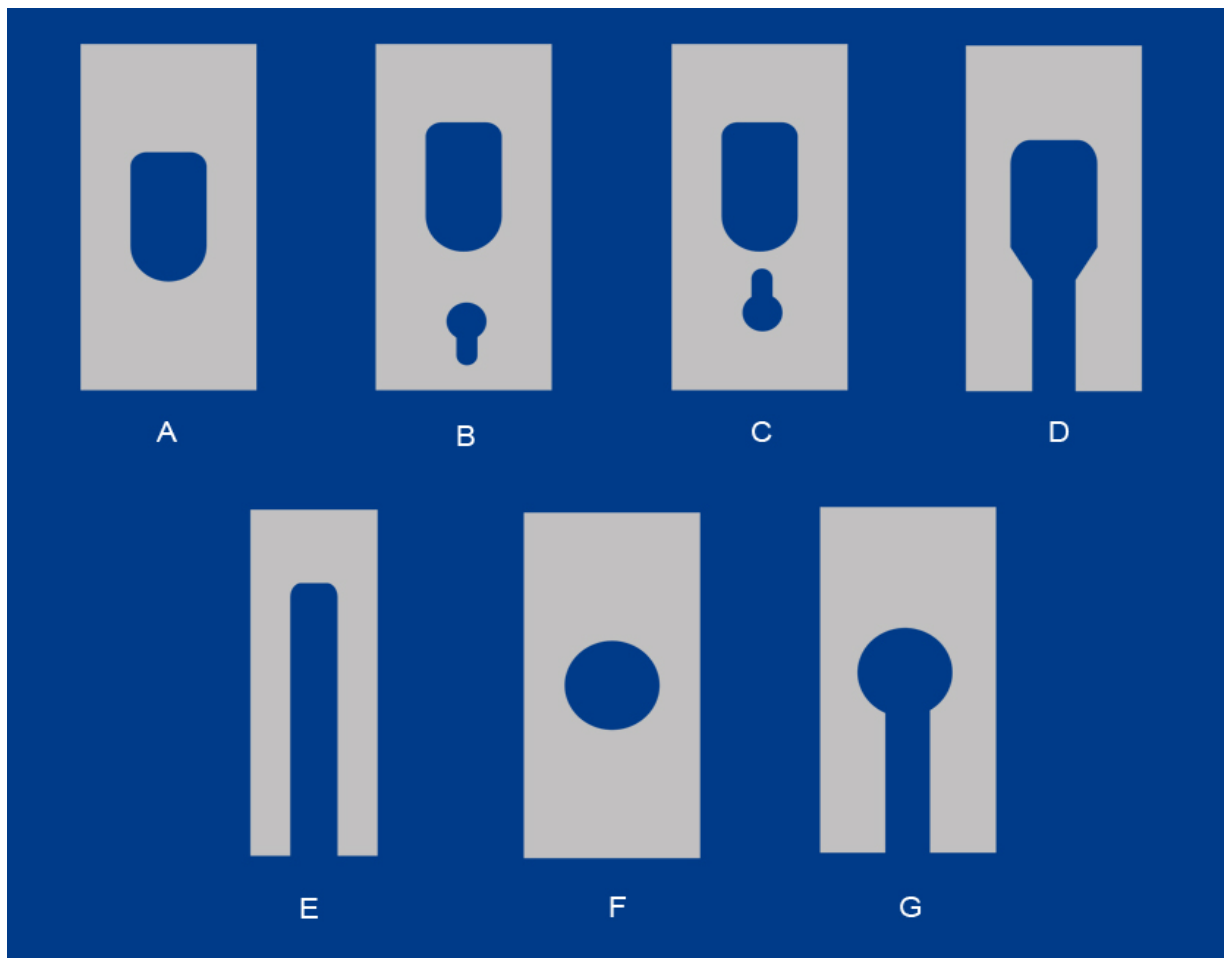

1. **According to ISO standard 1150**, These TRANSALLY drop wires comply with every application requirement for efficient operation on all automatic drawing-in systems, such as A, B & C type.
2. **According to ISO standard 441**, These types are not specifically designed for use on drawing-in machines, which are D, E & E type.
3. **Non-standardized drop wires**, These drop wires are for specific applications which include F, G, D, E & A & so on.











TRANSALLY Weaving Machine Accessories Co., Ltd.

Add: D1-701 Fuyuan Business Building, Futian Free Trade Zone, Shenzhen, P.R. China

Tel: +86 755 83567270, 83592700, 21105700, 21107600 Fax: +86 755 83567370

Web: www.transally.com.cn Email: info@transally.com.cn, transally@vip.163.com

Table of Drop Wires specifications

Model	Length (mm)	Width (mm)	Thickness (mm)	Weight (gram)	Pictures
CL 145	145	11	0.2	1.9	
			0.3	2.9	
			0.4	3.8	
			0.5	4.8	
CL 165	165	11	0.2	2.2	
			0.3	3.3	
			0.4	4.4	
			0.5	5.5	
CL 180	180	11	0.2	2.4	
			0.3	3.6	
			0.4	4.8	
OP 140	140	11	0.2	1.6	
			0.3	2.3	
			0.4	3.2	
OP 140N	140	7	0.2	0.8	
		8	0.3	1.4	
OP 145	145	11	0.2	1.7	
			0.3	2.5	
			0.4	3.3	
OP 156N	156	8	0.2	1.2	
			0.4	2.4	
OP 156	156	11	0.2	1.8	
			0.3	2.7	
			0.4	3.6	
			0.5	4.5	
OP 165	165	11	0.2	1.9	
			0.3	2.9	
			0.4	3.8	
			0.5	4.8	
OP 180	180	11	0.2	2.2	
			0.3	3.3	
			0.4	4.4	
			0.5	5.5	
OP 198	198	11	0.6	5.3	
		12	0.8	10	

TRANSALLY Weaving Machine Accessories Co., Ltd.

Add: D1-701 Fuyuan Business Building, Futian Free Trade Zone, Shenzhen, P.R. China

Tel: +86 755 83567270, 83592700, 21105700, 21107600 Fax: +86 755 83567370

 Web: www.transally.com.cn Email: info@transally.com.cn, transally@vip.163.com